

# HC5

## High Power Resonant Capacitors

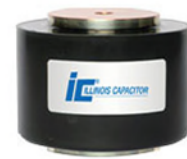

### FEATURES

High AC Voltage - High Current

### APPLICATIONS

Induction Heating - Tank Circuits

KVAR	500
CAPACITANCE TOLERANCE	+/-10%
MAXIMUM CORE TEMPERATURE	+85°C
SURFACE TEMPERATURE	+45°C (Above 45°C the KVAR rating must be de-rated by 2.25%/°C)
CONSTRUCTION	Self-healing
SELF INDUCTANCE	< 3 nH
DIELECTRIC	Polypropylene
FLAME RETARDANT	UL94V0

### Standard Part Listing

Capacitance (µF)	VAC	IC part number	Maximum RMS current (A)	MAX power kvar	Frequency range (kHz)	ESR (mΩ) 100kHz, +25°C	Dimensions (mm)			Terminal Style
							D	H	d	
1.2	1100	<a href="#">125HC5112KR</a>	600	500	55-96	1.5	80	71.5	60	R
1.4	1100	<a href="#">145HC5112KR</a>	600	500	46-83	1.2	80	71.5	60	R
3.0	750	<a href="#">305HC5750KR</a>	800	500	47-68	1.1	80	71.5	60	R
3.3	750	<a href="#">335HC5750KR</a>	800	500	43-62	1.0	80	71.5	60	R
4.0	900	<a href="#">405HC5900KR</a>	700	500	25-39	0.9	102	71.5	60	R
5.6	700	<a href="#">565HC5700KR</a>	1000	500	29-57	0.9	80	71.5	60	R
6.3	700	<a href="#">635HC5700KR</a>	1000	500	26-51	0.8	80	71.5	60	R
8.5	700	<a href="#">855HC5700KR</a>	1000	500	19-38	0.7	88	71.5	60	R
10	700	<a href="#">106HC5700KR</a>	1000	500	16-32	0.6	95	71.5	60	R
21	500	<a href="#">216HC5500KR</a>	1000	500	15	0.4	80	71.5	60	R
27	550	<a href="#">276HC5550KR</a>	1000	500	10-12	0.3	102	71.5	60	R
33	500	<a href="#">336HC5500KR</a>	1000	500	10	0.3	102	71.5	60	R
37	500	<a href="#">376HC5500KR</a>	1000	500	9	0.2	102	71.5	60	R

# HC5

## High Power Resonant Capacitors

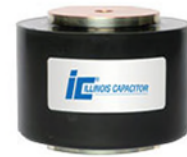

### Terminal Style: R

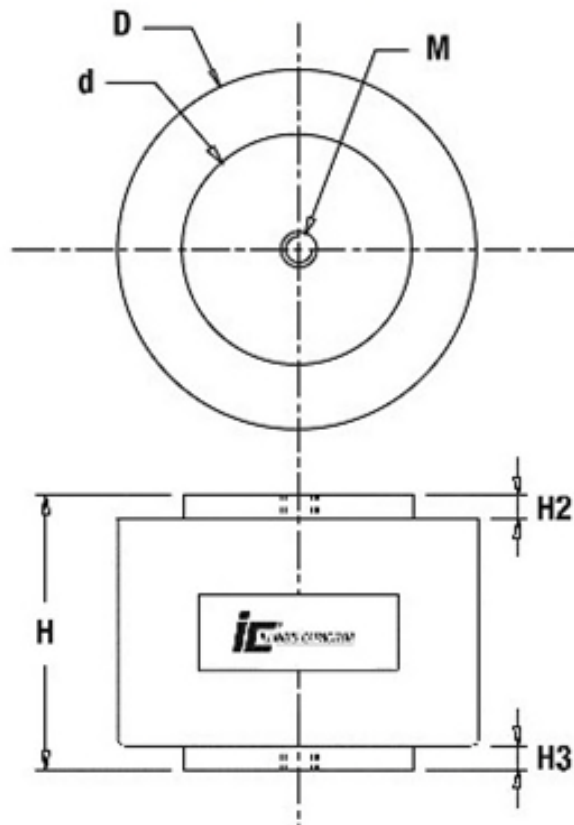

D	H	d	H2	H3
80 $\pm$ 1	71.5 $\pm$ 0.1	60 $\pm$ 1	6 $\pm$ 0.5	6 $\pm$ 0.5
88 $\pm$ 1				
95 $\pm$ 1				
102 $\pm$ 1				
Mounting holes (M): M8x1.25, 9.5mm deep with SS helicoil				
Terminations: Copper finish Rz6.3				
Tightening torque: 15Nm Max				

# HC5

## High Power Resonant Capacitors

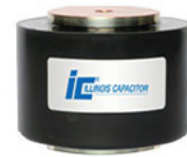

### Frequency Derating

— Voltage — Current — Power

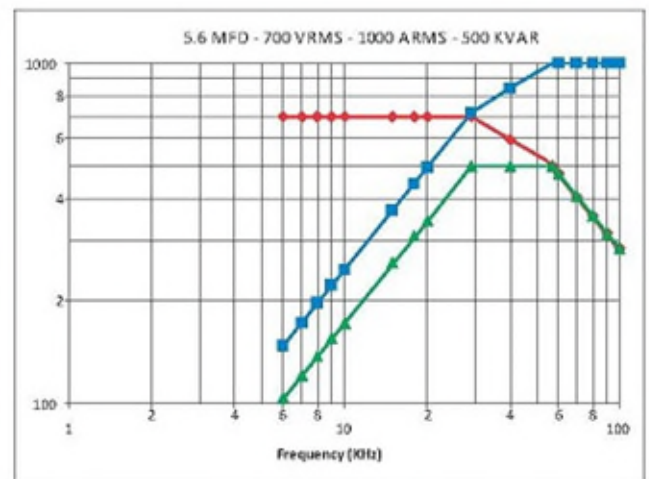
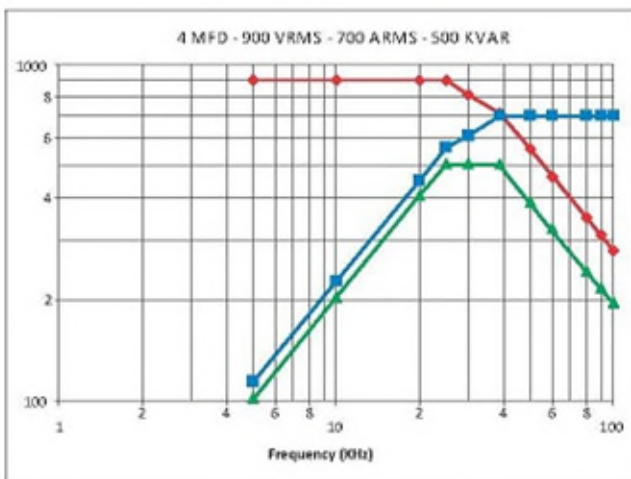
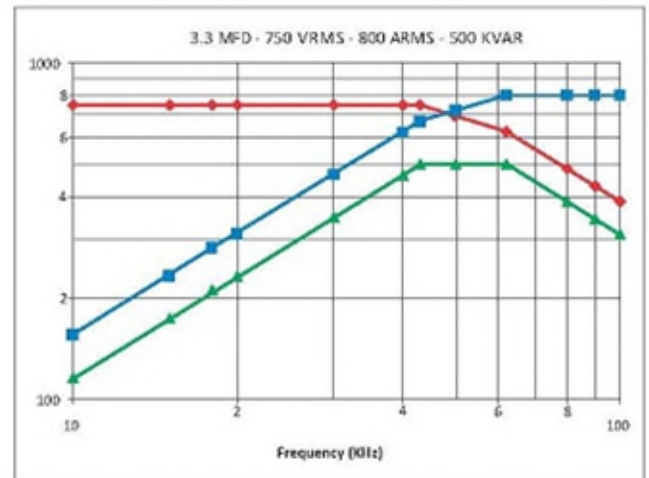
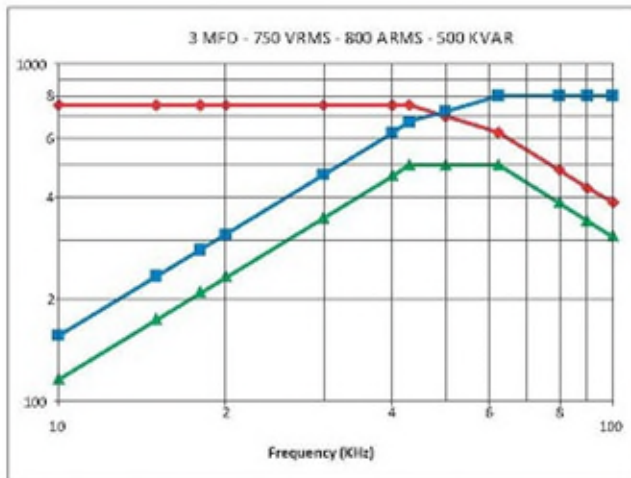
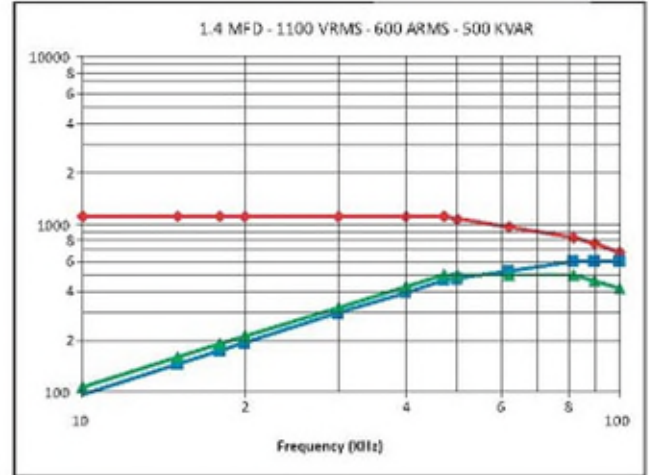
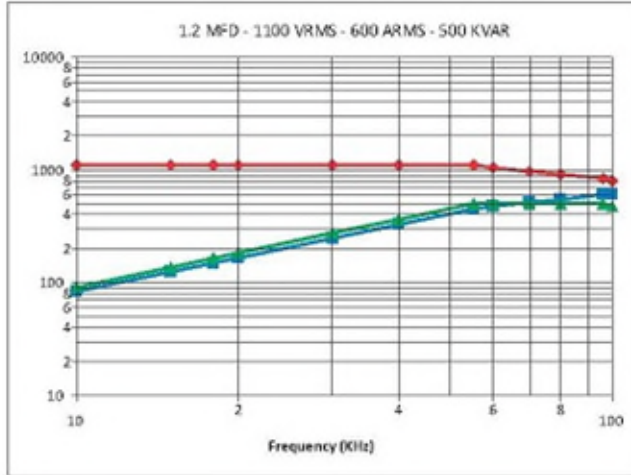

# HC5

## High Power Resonant Capacitors

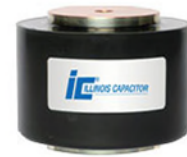

### Frequency Derating

—●— Voltage    —■— Current    —▲— Power

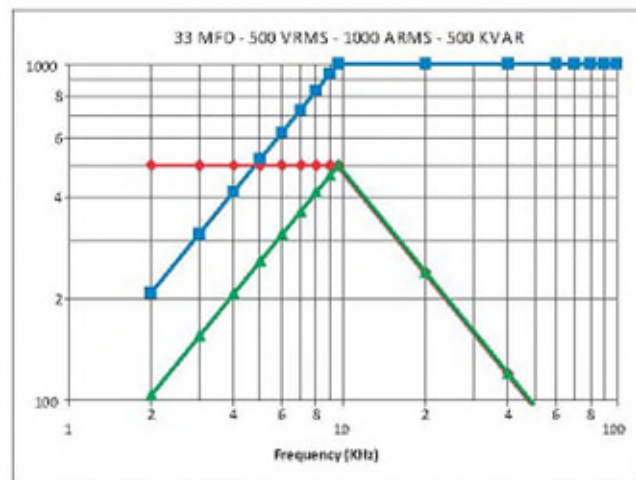
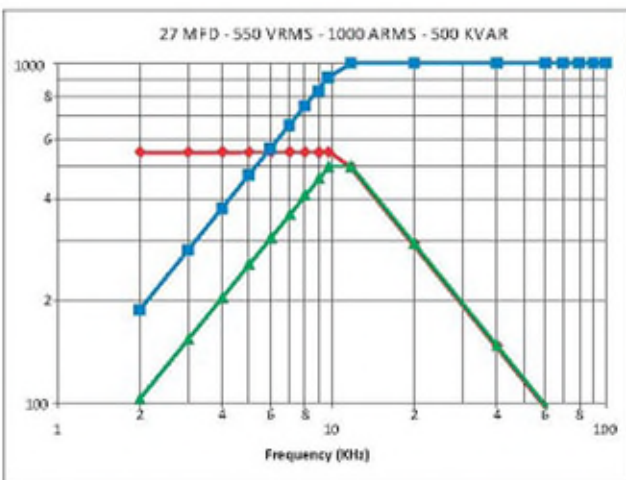
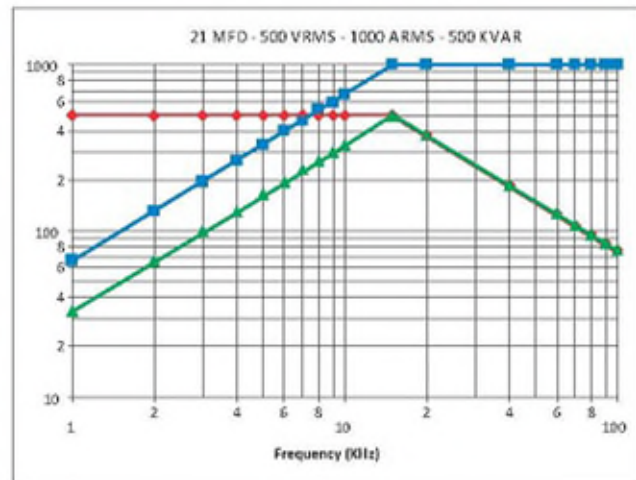
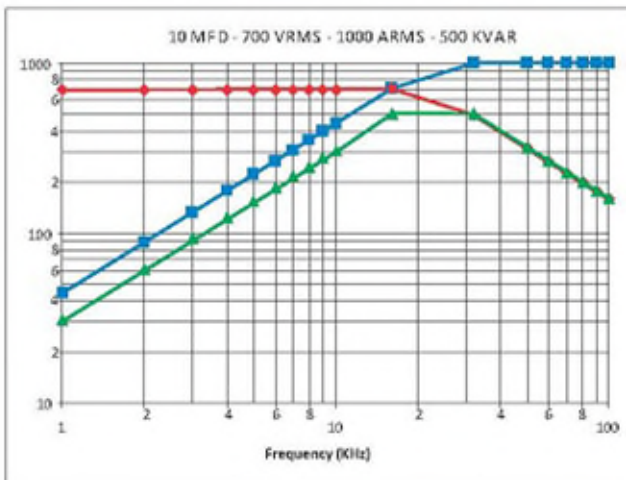
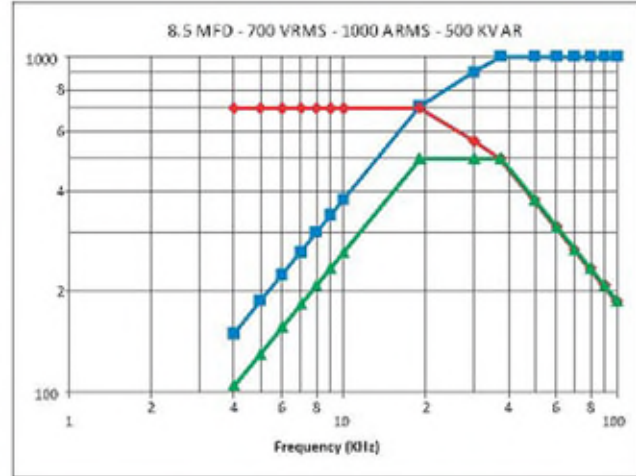
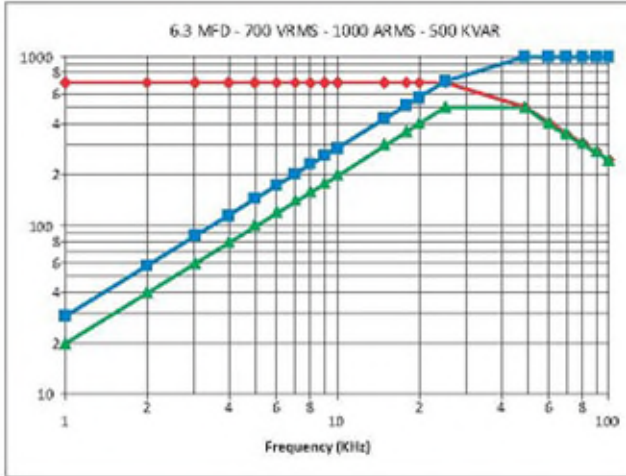

# HC5

## High Power Resonant Capacitors

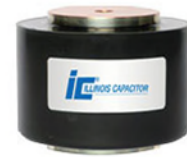

### Frequency Derating

