



332PPR202KE
HIGH DVDT/ PULSE
Parts are RoHS compliant

APPLICATIONS: SNUBBER, SCR commutation, TV deflection circuits

ELECTRICAL SPECIFICATIONS

Capacitance: 0.0033 uF	Tolerance: -10 % , +10 %
Dissipation Factor: 0.0005 Max at 1000 Hz and 25°C , 0.0005 Max at 10 kHz and 25°C , 0.0016 Max at 100 kHz and 25°C	Temperature Range: -55°C to +105°C
Temperature Coefficient: -200 PPM/°C: -100 PPM/°C, 100 PPM/°C	Above +85°C/+75°C the rated (DC/AC) voltage must be derated at per 1.25%/1.35%°C
Ripple Current: at and	WVDC: 2000 Volts DC
ESR: - at - and -	SVDC: N/A Volts DC
Self Inductance: 1 Nanohenries maximum per mm of pitch	VAC: 700 Volts AC
dvdt: 7000 V/μs	

Terminal to Terminal Dielectric strength: 1.6 times the rated DC voltage when applied between the terminals for 2 seconds
Terminal to case Dielectric strength: 0 VAC when applied between the terminals and case for 0

Insulation Resistance (Terminal to Terminal): 100000 MINIMUM after 100 Volts DC is applied for 60 seconds at 20°C
Insulation resistance (Terminal to Case): N/A Megohms MINIMUM after 0 Volts DC is applied for 0 seconds at 0

Reliability: 1 FIT
Load Life: 2000 hours at 85°C with 125% of rated voltage
Capacitance Change: ≤1% of initially measured value
D.F. Change: .001 of maximum specified value
I.R. Change: >50% of minimum specified value

PHYSICAL DIMENSIONS

Length (L): 18 mm, .35 mm	Lead Spacing (S): 15 mm, +/-0.4 mm
Height (H): 12 mm, +/- .35 mm	Lead Diameter (d): 0.8 mm, +/-0.05 mm
Thickness (T): 6 mm, +/- .25 mm	Lead Length (LL): 5mm, +/- 1 mm

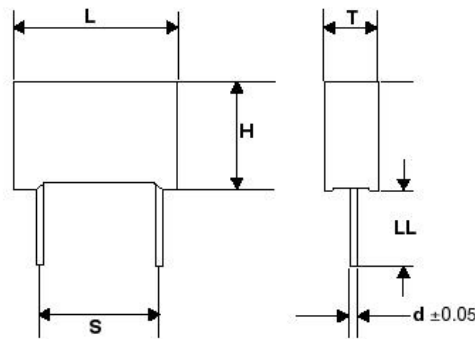

2400 East Devon Avenue Suite 292 Des Plaines, IL 60018 (847) 675-1760 FAX (847) 673-2850
 Illinois Capacitor (HK) Ltd., Tel: 85227930931, Fax: 85227930731, www.illcap.com.hk
 © Copyright 2020 Illinois Capacitor. An affiliate of Cornell Dubilier, All Rights Reserved